

HOBART701 S Ridge Avenue, Troy, OH 45374
1-888-4HOBART • www.hobartcorp.com**FP350
FOOD PROCESSOR****HOBART****STANDARD FEATURES**

- Red OFF, Green ON Button
- Compact Design
- Angled Front
- Planetary Drive
- Large Full Size Feed Hopper
- All Aluminum Hopper and Housing
- Double Interlock Switch
- Plate Speed of 430 RPMs
- Decoring Screw

ACCESSORIES

- 3-Pack Plates: $\frac{1}{16}$, $\frac{5}{32}$ slicer plates, $\frac{5}{16}$ shredder plate, 1 wall rack
- 6-Pack Plates: $\frac{1}{16}$, $\frac{5}{32}$, $\frac{3}{8}$, $\frac{7}{32}$ slicer plates, $\frac{5}{16}$ shredder plate and $\frac{3}{8}$ dicer plate, 2 wall racks
- 3-Peg Wall Rack: designed to hold three plates for additional plate storage
- Slicer Plates: $\frac{1}{16}$, $\frac{1}{8}$, $\frac{5}{32}$, $\frac{7}{32}$, $\frac{5}{16}$, $\frac{3}{8}$, $\frac{9}{16}$; $\frac{3}{16}$ crimping plate
- Julienne Plates: $\frac{5}{64}$, $\frac{5}{32}$, $\frac{7}{32}$, $\frac{3}{8}$
- Dicer Grids: $\frac{7}{32}$, $\frac{3}{8}$, $\frac{1}{2}$, $\frac{5}{8}$, $\frac{3}{4}$, and 1
- Shredder Plates: $\frac{1}{16}$, $\frac{3}{32}$, $\frac{1}{8}$, $\frac{3}{16}$, $\frac{5}{16}$, $\frac{7}{32}$
- Grater Plate: Fine, Hard Cheese
- French Fry: $\frac{3}{8}$
- Machine Table: Adjustable height table to hold Food Processor
- Adjustable height stainless steel lug cart
- Stainless steel receiving pan
- Plastic receiving pan

MODELS

- FP350 Continuous Feed Full Hopper Food Processor

Specifications, Details and Dimensions on Inside and Back.

**Standard with Pusher Plate****FP350 FOOD PROCESSOR**

FP350 FOOD PROCESSOR



701 S Ridge Avenue, Troy, OH 45374
1-888-4HOBART • www.hobartcorp.com

SOLUTIONS/BENEFITS

Red OFF, Green ON Button

Ease of use

- Operator can readily recognize

Compact Design

Ease of use, small footprint, reduced labor, increased sanitation and productivity

- Occupies minimal counter space
- Unit and receiving pan fit on 27" deep counter
- Plates remove in seconds
- Feed hopper removes without tools for ease of cleaning
- Produces consistent quality product results in seconds
- Production capability for 26 lbs. per minute

Angled Front

Operator convenience, ease of use

- 45° angle for ease of product loading
- Helps to reduce operator fatigue

Planetary Drive

Performance, reliability

- Helps to prevent stalling under heavy loads
- No rest times required between loads

Large Full Size Feed Hopper

Flexibility, convenience, reduced labor

- Supports processing capabilities for large variety of products
- Design permits continuous cutting of long products
- Eliminates precutting

All Aluminum Hopper and Housing

Durability, sanitation

- Anodized finish resists harsh cleaners
- Easy clean up

Double Interlock Switch

Protection

- Prevents machine from running when pusher plate swings away or is open

Plate Speed of 430 RPM

Product quality and consistency

- Precise cutting and dicing action without bruising or mashing of products

Decoring Screw

Quality, consistency

- Deflects products away from the plate hub for complete processing

SPECIFICATIONS

DESIGN: Compact, conveniently designed at 45° angle for operator convenience. Base occupies minimal counter space. Housing constructed of anodized aluminum with rubber feet on base to prevent movement or skidding. Removable hopper front is burnished aluminum.

ELECTRICAL: 120/60/1, 3 Conductor power cord (14 AWG) is 6 feet in length.

MOTOR: 10 amps. Gear driven operating at 430 RPM output. 1 H.P. with overload protection.

SWITCHES: Easy to operate (red) OFF and (green) ON switch. Pusher plate and hopper front are interlocked.

STANDARD EQUIPMENT: Basic unit comes with deflector plate, decoring screw and cleaning brush.

WARRANTY: Unit has full one-year warranty on parts, labor and mileage against manufacturer's defects. Service contracts are available.

CUTTING TOOLS: The plates feature stainless steel construction with cutlery grade stainless steel knives. Plate combinations for dicing are shown in the chart to the right.

WEIGHT: Net - 71 lbs. Approximate Shipping - 77 lbs.

FP350 & FP400 Food Processors												
	S35DICE-7/32	S35DICE-9/32	S35DICE-3/8	S35DICE-1/2	S35DICE-1/2LOW	S35DICE-5/8	S35DICE-5/8LOW	S35DICE-3/4	S35DICE-3/4LOW	S35DICE-1	S35DICE-1LOW	S3FRY-3/8
3SLICE-1/32-SS												
3SLICE-1/16-SS												
3SLICE-1/8-SS	✓	✓	✓	✓		✓		✓		✓		
3SLICE-5/32-SS	✓	✓	✓	✓		✓		✓		✓		
3SLICE-7/32-SS	✓	✓	✓	✓		✓		✓		✓		
3SLICE-5/16-SS		✓	✓	✓		✓		✓		✓		
3SLICE-3/8-SS			✓	✓		✓		✓		✓		✓
3SLICE-9/16AL							✓		✓		✓	
35SFSLC-5/16		✓	✓	✓		✓		✓		✓		
35SFSLC-3/8			✓	✓		✓		✓		✓		
35SFSLC-1/2					✓		✓					
35SFSLC-5/8							✓					



701 S Ridge Avenue, Troy, OH 45374
1-888-4HOBART • www.hobartcorp.com

FP350 FOOD PROCESSOR

FOOD PROCESSOR ACCESSORIES

A wide variety of plates are available to tackle any food processing application. The construction of all accessories makes them dishwasher safe.

Slicer Plates:

Standard Slicing & Crimping Slicing Plates are used for cutting of soft or hard fruits and vegetables. The formed stainless steel plates with stainless steel hub and drive slot provides a strong, rigid mounting for repeatable operation. Cutlery grade stainless steel knives give sharp, reliable, long lasting cuts to any product. The knives are removable for fast, easy, cost effective replacement of these wear items while reusing the plate. Some plates have double knives for higher volume operations. Straight or decorative crinkle cut blades are available. These plates may be used in conjunction with suitable dicing grids for cubing of products.



Fine Slicer Plates:

These Fine Slicer Plates are used for cutting soft or hard fruits and vegetables. The plate is machined from a special aluminum alloy designed to withstand dishwasher cleaning. The round edge cutlery grade stainless steel knife slices through product cleanly for reliable, repeatable cutting action. The knife is removable for fast, easy, cost effective replacement of this wear surface while reusing the plate.



Soft Slicer Plates:

The Soft Slicer Plates are specifically designed for more delicate fruits and vegetables such as tomatoes, bananas, plantains, kiwi, etc. The plate is machined from a special aluminum alloy designed to withstand dishwasher cleaning. The straight edge knife and plate configuration cleanly cut through the delicate fruits and vegetables without damaging the product. The knife is removable for fast, easy, cost effective replacement of this wear surface while reusing the plate.



Julienne Plates:

Julienne Cutter Plates are suitable for firm products and are often used for soups, stews, French fries, and decorations. The plate creates long, square, curved strings of product. The formed stainless steel plates with stainless steel hub and drive slot provides a strong, rigid mounting for repeatable operation. Cutlery grade stainless steel knives give sharp, reliable, long lasting cuts. The julienne cutter knife unit is removable for fast, easy, cost effective replacement of these wear items while reusing the plate.



Shredder Plates:

Shredder plates are used for cheese, cabbage, nuts, dry bread, etc. The cast stainless steel frame, hub, and drive slot provide a strong, rigid mounting for repeatable operation. The stainless steel cutting plate gives sharp shredding action to the product. The cutting plate is removable for fast, easy, cost effective replacement of this wear surface while reusing the mounting frame.



Grater Plates:

Grater plates may be used for hard dry cheese, carrots, potatoes, cabbage, dry bread, etc. The grater plate creates a fine granular/powdery product. The cast stainless steel frame, hub, and drive slot provide a strong, rigid mounting for repeatable operation. The stainless steel cutting plate gives sharp grating action to the product. The cutting plate is removable for fast, easy, cost effective replacement of this wear surface while reusing the mounting frame.

Dicing Grids:

Dicing grids are used in conjunction with slicing plates to produce various sized cube and rectangular shaped products for stews, salads, soups, and a wide variety of other applications. The dicing grid frame is cast stainless steel and provides a strong, rigid mounting for repeatable operation. The grid knives are cutlery grade stainless steel and give sharp cutting action to the product for precise, repeatable control of the product shape. The cutting knife set is removable for fast, easy, cost effective replacement of these wear surfaces while reusing the mounting frame.

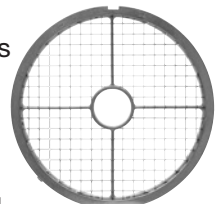

FP350 FOOD PROCESSOR



701 S Ridge Avenue, Troy, OH 45374
1-888-4HOBART • www.hobartcorp.com

DETAILS AND DIMENSIONS

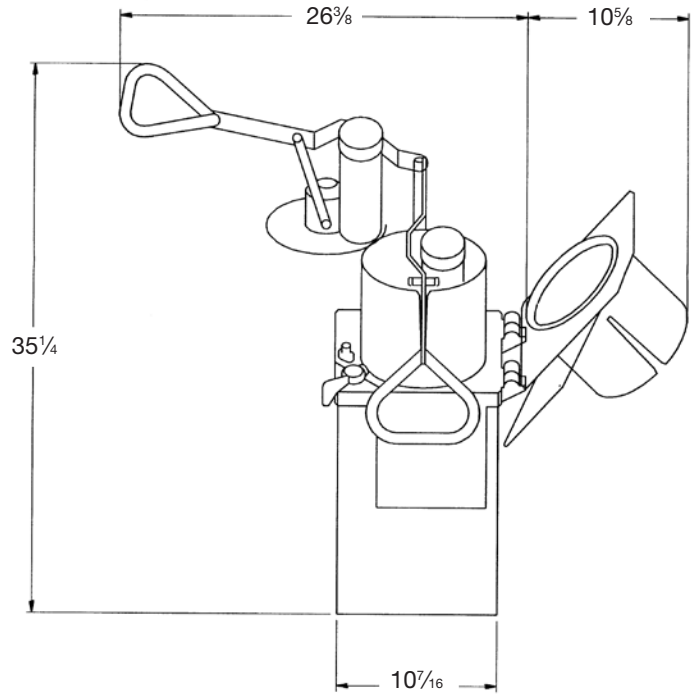
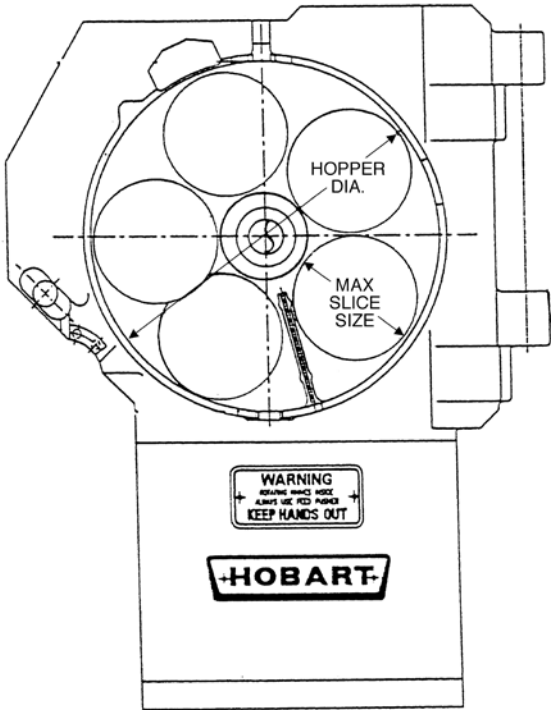

FP350

Hopper Diameter	7 3/8"
Maximum Slice Size	3"
Usable Depth	7"
Feed Tube Diameter	2 5/16"

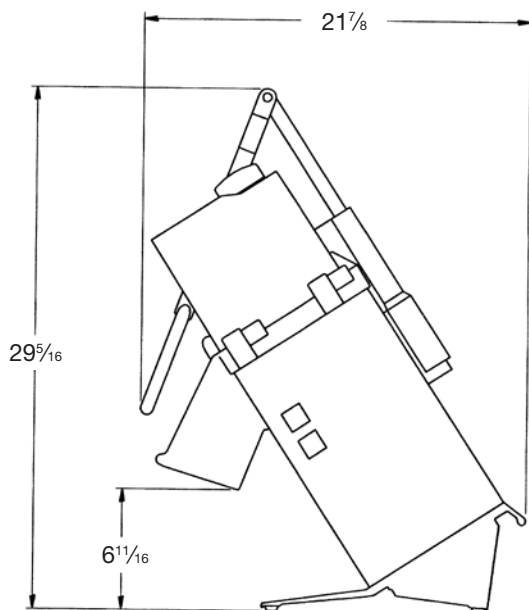

6 FT. CORD MIN.
WITH NEMA 5-15P PLUG

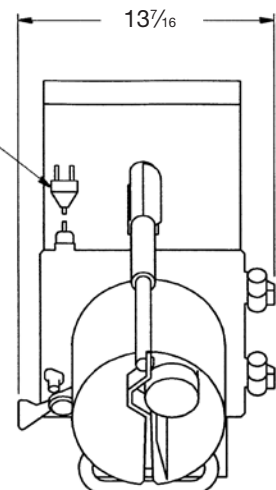

As continued product improvement is a policy of Hobart, specifications are subject to change without notice.